









Cable junction boxes "Outdoor - harsh environment and (or) outdoor"



KF 5355

- 16-35 mm², Cu 3~









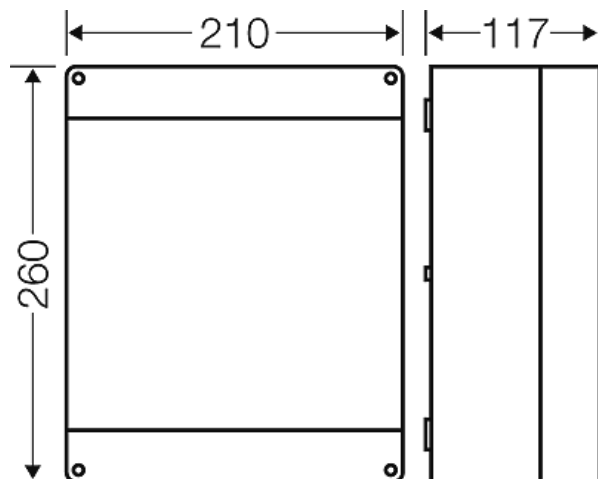

- with terminals
- 5-pole per pole 6 x 16 mm² s, 4 x 25 mm² s, 4 x 35 mm² s, 2 x 50 mm² s
- cable entry via knockouts, order ASS separately (refer to index cable entry systems)
- "Outdoor - harsh environment and (or) outdoor"
- colour: black, RAL 9011

rated insulation voltage	AC/DC 690 V
current carrying capacity	125 A
tightening torque for terminal	12,0 Nm
Degree of protection:	IP 66
Material:	PC-GFS (polycarbonate)
width	210 mm
height:	260 mm
depth	117 mm
Weight	2,175 kg
in accordance with	IEC 60 670-22
in accordance with	Det Norske Veritas Certificate No.: E-9149

Drawings

Dimension drawing







Cable junction boxes "Outdoor - harsh environment and (or) outdoor"



KF 5355

- 16-35 mm², Cu 3~







Detail mass

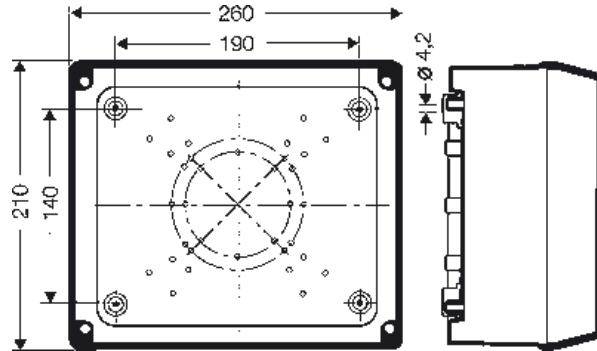

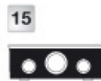
box walls



1 x M 20/25
2 x M 40/50

2 x M 25/32
1 x M 40/50

Operating and ambient conditions

Application area	Suitable for outdoor installation (harsh environment and/or outdoor). To reduce the formation and accumulation of condensed water see technical information.
Resistant to occasional cleaning procedures (direct jet)	Resistant to occasional cleaning procedures (direct jet) with high-pressure cleaner without additives, water pressure: max. 100 bar, water temperature: max. 80° C, distance => 0,15 m, in accordance with the requirements IP 69K, enclosure and cable glands at least IP 65
Ambient temperature	Average value over 24 hours + 55 °C Maximum value + 70 °C Minimum value - 25 °C
Relative humidity	50% at 40° C short-time 100% at 25° C
Fire protection in the event of internal faults	Demands placed on electrical devices from standards and laws Minimum requirements - Glow wire test in accordance with IEC 60 695-2-11: - 650°C for boxes and cable glands - 850°C for parts of insulating material necessary to retain current carrying parts in position
Burning behaviour	Glow wire test IEC 60 695-2-11: 960 °C UL Subject 94: V-0 flame resistant self-extinguishing

Cable junction boxes "Outdoor - harsh environment and (or) outdoor"



KF 5355

- 16-35 mm², Cu 3~







IP
66





PC





RAL
9011





15
Wall
15



Degree of protection against mechanical load	IK08 (5 Joule)
Toxic behaviour	halogen-free silicone-free "halogen-free" in accordance with the examination of the cables and insulated wires - corrosiveness of fumes - as per IEC 754-2
Note:	For material properties see technical data.